

# Data Sheet



Article number: 201575280

Description: E+G Handwheel  
GN 950.6-100-K10-A

## Measures

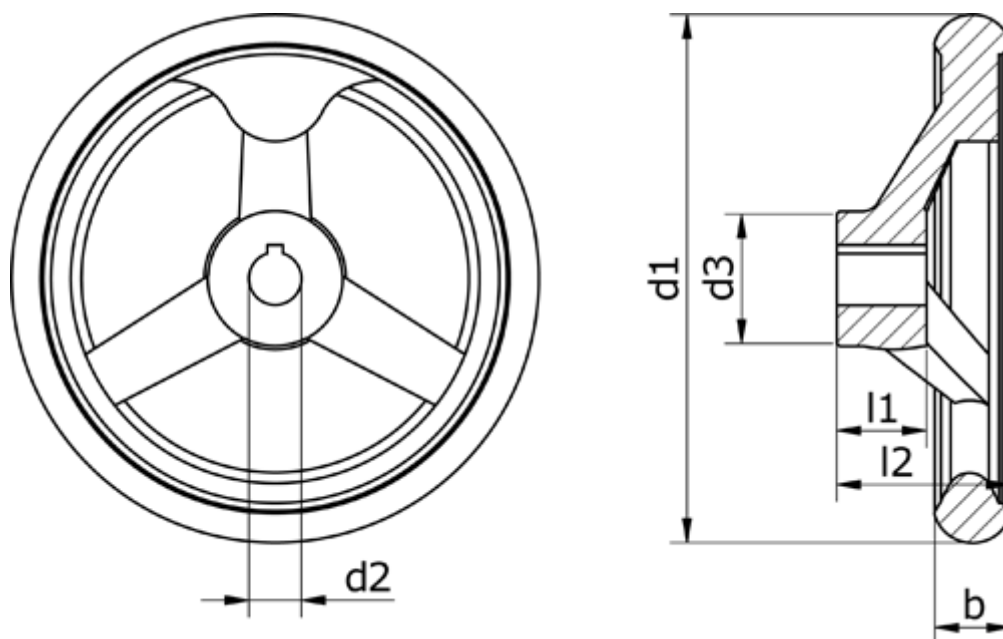

b1 = 14.5

d1 = 100

d2 = 10

d3 = 25.5

d4 = M6

l1 = 17

l2 = 33.0